

# ZT1-1942S

1" PP 长条形 全频 模块

## Datasheet

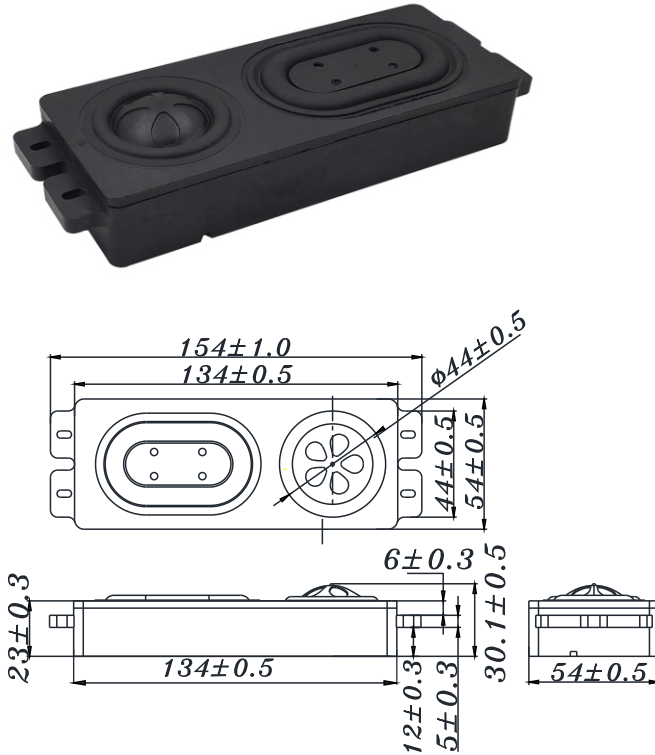

DIAPHRAGM	PP. composite with elastomer
HOUSING	PP composite material
IMPEDANCE	4 ohm
MUSIC POWER	8 W
RESPONSE RANGE	78 Hz - 20KHz (-6dB)
SENSITIVITY	81 dB (M / W)
Fs	78 Hz

**TB** Speaker